



pegasus

Intelligent Time Attendance Recorder & Access Controller

Access Control/Time & Attendance / Lift Access Control System/ Security

PP-3702/T Series Operational Manual Ver.11.1

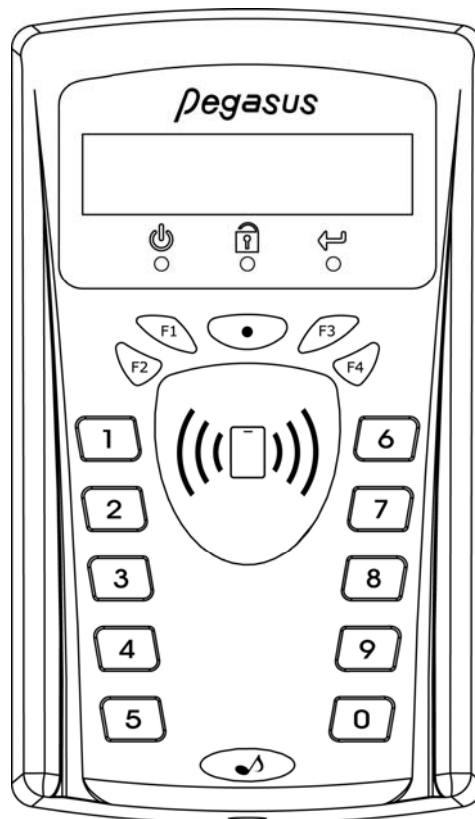



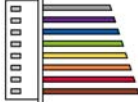





Table of contents

System introduction	1
General features	1
Specification	3
LCD instruction	4
Panel description	6
Bottom view	6
Wiring connectors and PIN assignment	7
How to connect PP-3702T to a computer?	1
Example of wiring	1
Controller and relay box wiring example	1
Brief system programming	1
Change the master PIN	1
Function code instruction	1
F0: Delete all personal map	17
F1: Access by key in user ID through master PIN	17
F2: Set weekday, hour, minute	18
F3: Calendar year, month and date setting	18
F4: Parameters & Modes	18
Group 0. System initiation	3
Group 1. Input commands	3
Group 2. Output commands	3
Group 3. Operation modes	3
Group 4. PIN or master PIN setting	3
Group 5. Inquiry mode	3
Group 6. Time zone mode/add card mode	3
Group 7. Delete card mode	3
Group 8. System configurations	3
Group 9. Factory configuration	3

F5 : Inquiry mode	19
A. Single card inquiry	1
B. Inquiry with learning mode	1
C. Inquiry card status by block mode	1
F6: Add personal map	2
A. Add card no.	2
B. Add card no. and PIN	2
C. Add card with learning mode	2
D. Add card with block mode	2
F7: Delete personal map	2
A. Delete single card	2
B. Delete card with leaning mode	2
C. Delete card with block mode:	2
D. Delete card with block mode	2
F8: Time zone/holiday/bell programming	2
A. Personalized mode	2
B. Free access mode	2
C. Holiday mode	2
D. Bell alarm mode	2
F9: Modify events counter for event retrieving	3
F* : Inquiry and display the stored events	3
Simple and easy trouble shooting	3
Appendix	4

Packing list

Before getting start, please check the PP-3702/T package contains the following items:

	DESCRIPTION	Q'TY	
	The system unit	1 unit	
1	9 Pin connector (Blue)	1 pc	
2	8 Pin connector (White)	1 pc	
3	5 Pin connector (White)	1 pc	
4	4 Pin connector (White)	2 pc	
5	Screw	1 pc	
6	Free wheeling diode	1 pc	
7	Sealing rubber for waterproof	1 pc	

System introduction

PP-3702/T is an intelligent time recording terminal designed to meet the variant applications in time attendance and access control, lift control & ARM/DISARM security requirements. Each terminal can be operated independently or through PC/Internet adapter PC-T100 to fulfill the multiple terminal system. The recording terminal includes nearly all the necessary functions for time recording and access control. Users can use master PIN to select the desired functions from the abundant functional list (For malfunction, please contact with your local distributors)

The system could be started by modifying the factory defaulted templated as by code F4 + 0850 and then save them by 0650 to back up for farther configuration your system by 0950, if you confused your configuration.

General features

1-A Time recording features:

- 1 \ High capacity with 8 digits card number / 6 digits staff number and 8 character English name.(Either checking or without checking personal map)
- 2 \ 16 characters x2 rows of LCD display with 8 digits which have year, month, day, week, time, IP, operation mode, real time mode, unlock time, door monitoring.
- 3 \ 79 duty codes, duty name defined by PC.
- 4 \ Selectable batch or real time on-line mode.
- 5 \ Key in 8 digits ID for time attendance recording.
- 6 \ Totally 192 alarm schedules (8 schedules per hour) dry contacts output for periodic bell announce.

There are 6 versions available:

- (1)K Version: 1,000 card capacity, 500 events.
 - (2)L Version: 2,000 card capacity, 1,000 events.
 - (3)M Version: 30,000 card capacity, 10,000 events.
 - (4)N Version: 11,000 card capacity, 32,000 events.
 - (5)P Version: 11,000 card capacity, 8,000 events.
 - (6)X Version: 32,000 card capacity, 32,000 events.
- Versions could be getting thru the equipped RS-485 interface.

1-B. Access control features: (Main application)

1. System parameters and personal access map can be down loaded by PC or manually programmed through keypad.
2. The personal access map is consisted of card ID, staff number and staff name, PIN and Time Zone Status, expiry date and Anti-passback. Operation modes : (1) card only (2) card + PIN (3)Door PIN only and duress feature (4)Card no +PIN and duress feature(5)Free access (6) Automatic operation mode by time zones

NOTE: The staff name is used under F4=9601, 3400 cards capacity only.

3. Individual personal access map can be added/deleted and checked by on-lined PC or through manually in single / block range card number or by direct reading card in learning mode.
4. Selectable immediate or batched serial output for event printing
5. With complete door release, status monitoring and intruded alarm period & error trials.

Specification

Dimensions	: 174mm(L) x 100mm(W) x 43mm(H)
Weight	: 600g± 5%
Power supply	: DC 12V±10%, 80mA~100mA(not include power requirement for lock & alarm)
Transmission rate	: Default 9,600 bps N,8,1(2,400bps/4,800bps) (19,200bps/38,400bps<selectable>)
Operating temperature	: 0°C ~ 70°C
Operating humidity	: 10%~90%
Keypad	: For system programming, pass word entry or duty code selection.
Password	: Programmable 4 digits PIN for each person
Serial interface	: RS-485 & RS-232 & TCP/IP
Serial output	: 1.To link with PG-1050B printer interface adaptor for Centronics printer port or direct to serial printer *2. To drive DDR (digital door relay) for safety control model. 3. Lifts controller. common door codes
Events/card capacity	: (1) K Version: 1,000 card capacity, 500 events. (2) L Version: 2,000 card capacity, 1,000 events. (3) M Version: 30,000 card capacity, 10,000 events. (4) N Version: 11,000 card capacity, 32,000 events. (5) P Version: 11,000 card capacity, 8,000 events. (6) X Series: 32,000 card capacity, 32,000 events. Other capacity combination requested by order
Card standard	: EM 125KHz / Mifare 13.56MHz(ISO 14443A or ISO 14443B) / HID 125KHz(Depending on order) Wiegand 26/34 bits port for any kind of reader
External Reader	: With one or optional two port for external Wiegand (26/34 bits definable by command) & ABA input(by order)

LCD instruction

Normal Display: After plug-in power, LCD displays as below:

Y Y / M M / D D
h h : m m XXX. +NNNNN

Y Y / M M / D D: The calendar year, month and date (Year/ Month/ Day)

h h:mm : System clock, Hour & Minute (hh=00~23;mm=00~59)

X X X : weekday Monday to Sunday

NNNNN : The transaction records stored in the buffer.

When display shows “FULL”, which means the butter is full. Please download the records by PC or press Master PIN and then press”9”,key-in “000000” to erase the events.

Parameter display: key-in “9”, LCD displays as below:

First display	<table style="margin: auto; border-collapse: collapse;"> <tr> <td style="padding: 0 10px;">Aaa</td> <td style="padding: 0 10px;">W t</td> <td style="padding: 0 10px;">t t</td> <td style="padding: 0 10px;">96</td> </tr> <tr> <td style="padding: 0 10px;">A D R .</td> <td style="padding: 0 10px;">W A T .</td> <td style="padding: 0 10px;">D O R .</td> <td style="padding: 0 10px;">B P S</td> </tr> </table>	Aaa	W t	t t	96	A D R .	W A T .	D O R .	B P S	<p>← Parameter value</p> <p>← Parameter name</p>
Aaa	W t	t t	96							
A D R .	W A T .	D O R .	B P S							

Aaa : Polling address by F4=88aa (00~99)

WAT : Real time on-line waiting time by F4=890t (0~9), “0” for baten mode by F4=99nn

DOR : Door released time by F4=21tt(00~99)

BPS : Buad Rate 96=9600 48=4800 24=2400 19=19200

Second display	<table style="margin: auto; border-collapse: collapse;"> <tr> <td style="padding: 0 10px;">N</td> <td style="padding: 0 10px;">Wt</td> <td style="padding: 0 10px;">t t</td> <td style="padding: 0 10px;">N-N</td> </tr> <tr> <td style="padding: 0 10px;">R E P .</td> <td style="padding: 0 10px;">M O T .</td> <td style="padding: 0 10px;">D P T .</td> <td style="padding: 0 10px;">T - A</td> </tr> </table>	N	Wt	t t	N-N	R E P .	M O T .	D P T .	T - A	<p>← Parameter value</p> <p>← Parameter name</p>
N	Wt	t t	N-N							
R E P .	M O T .	D P T .	T - A							

REP : Door Monitoring Status time for check repeat reads in unit of second

N=t Check repeating card with t minutes

N=0 No repeating card check

MOT: Door monitoring time by code F4=230t

DPT : LCD message display time by $F4=250t$, useful for $F*$

T-A :Time zone control – Free access mode

Y - Enable function

N -Disable function

***Note:** The system could be operated in proper order only **when the address code is correctly programmed through 88nn**. If the reader address is not correctly programmed, the display of address will show some other ASCII characters as “xxx“ above the ADR.which can't save the event; therefore you should program again.

Third display

R.r r r r r	W.w w w w w
Version	P372P36Q

R.rrrrr: The read counter of buffer

W.wwwww: The write counter of buffer

Version:CPU version

Note: Accoring to actual version.

Panel description

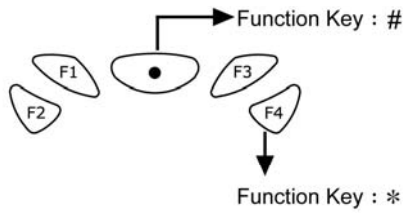
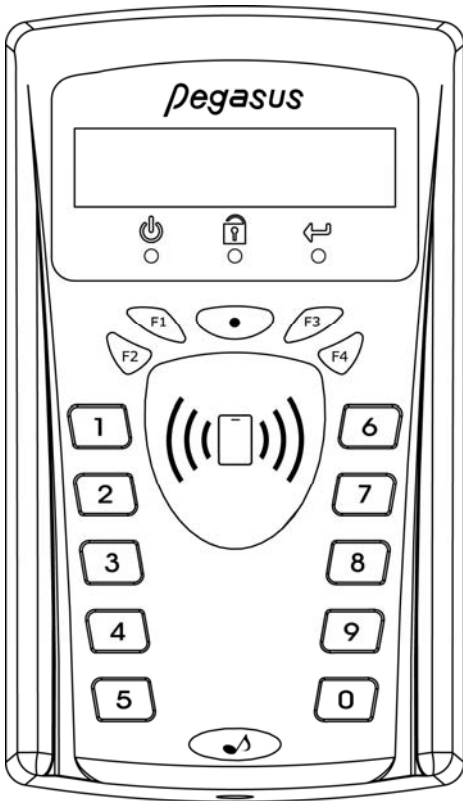

-  : Power LED
-  : State LED
-  : Doorbell

Bottom view

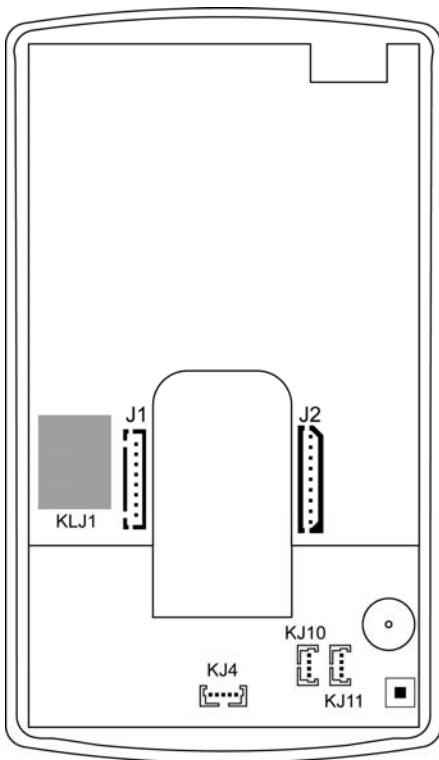

J1-8 pins connector for Communication and alarm output

J2-9 pins connector for Access port

KJ10- 4 pins connector for external reader

KJ11-4 pins connector for external reader(Optional)

KJ4-5 pins connector for bell output

KLJ1-RJ-45(For TCP/IP)

Wiring connectors and PIN assignment

A. J2-9P Blue (For power input and access functions)

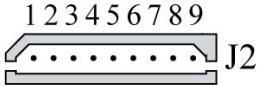

A. J2-9P Blue (For power and access control)

- | | | | |
|-------------|-------------|---|--|
| 1. (Red) | ← Power "+" | → | +12V DC input |
| 2. (Black) | ← Power "-" | → | GND |
| 3. (Brown) | ← COM | → | Relay A (COM) |
| 4. (Orange) | ← NO | → | Relay A (NO) |
| 5. (Yellow) | ← NC | → | Relay A (NC) |
| 6. (Green) | ← | → | Exit push button |
| 7. (Blue) | ← | → | Door Monitor |
| 8. (Purple) | ← | → | Security sensor |
| 9. (Gray) | ← | → | Serial output.(RS-232 or open collector) |

* Note:

Please connect the blue wire to GND if the Door Monitoring function is unnecessary.

Please connect the purple wire to GND if the Security Sensor function is unnecessary.



B. J1-8P White (For on-line interface & alarm output)

	RS-485	RS-232
A.(Brown) Receive Data(RxD+)	←	---
B.(Red) Inverted Receive Data(RxD-)	←	---
C.(Orange) Transmit Data(TxD+)	→	TxD
D.(Yellow) Inverted Transmit Data(TxD-)	→	RxD
E.(Green) Alam output in dry contact(COM)	—	---
F.(Blue) Alam output in dry contact(NO)	—	---
G.(Purple) Data Terminal Ready	→	---
H.(Gray) Singal Ground	—	SG

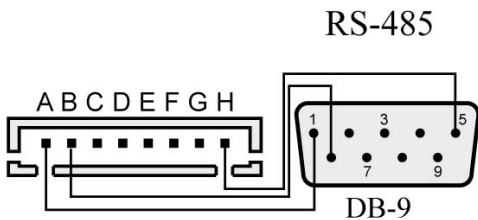

J1 connect to TCP/IP or RS485 converter

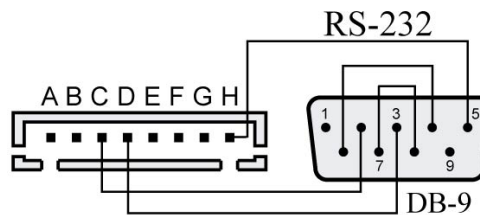

J1 connect to DB9(PC)



C. KJ4-5P White (For Tamper switch and bell output)

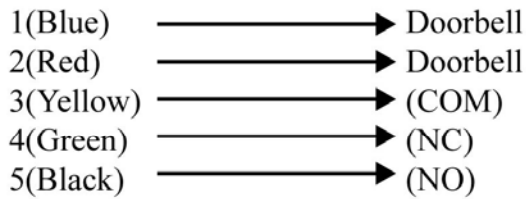

D. KJ10/KJ11-4P White (For external reader)

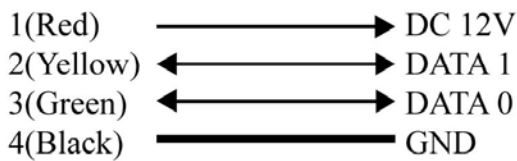

- Note :**
1. The distance between Main reader and external reader should be over 30cm to prevent mutual interference.
 2. Please put some more no-metal plate between the reader & metal plate to enhance the reading distance.

E. KLJ1-RJ-45(For TCP/IP)

	PIN Number	Signal
	1	TPTX+
	2	TPTX-
	3	TCT
	4	NC
	5	NC
	6	RCT
	7	TPRX+
	8	TPRX-

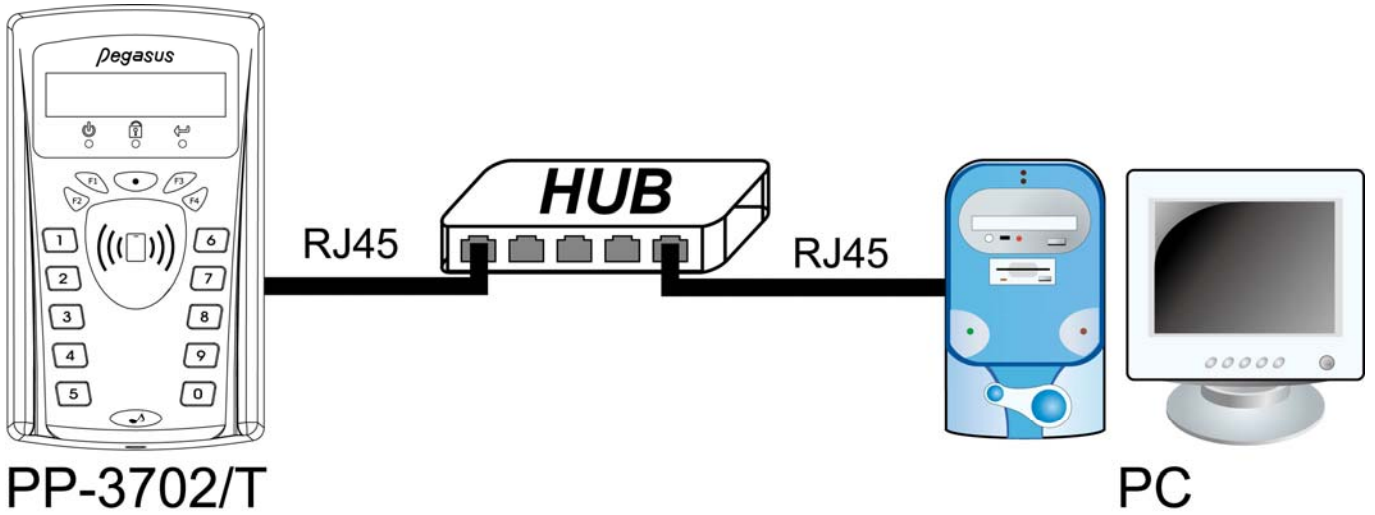

Note: Via RJ45 cable to a computer directly
Please change one of the RJ45 connector (crossing).

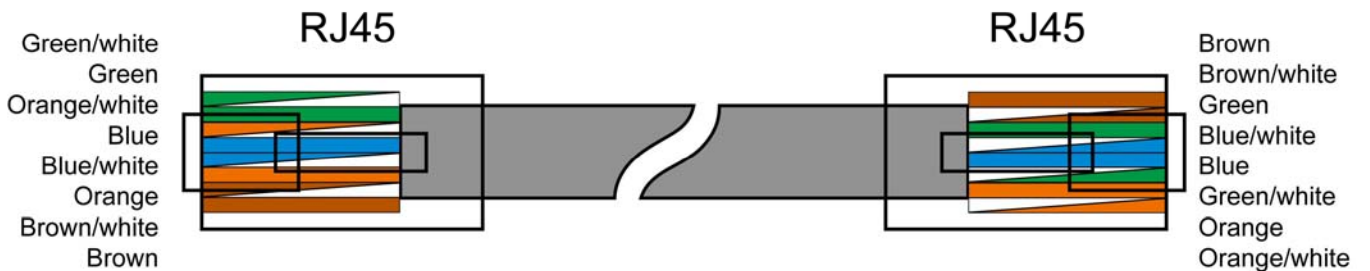
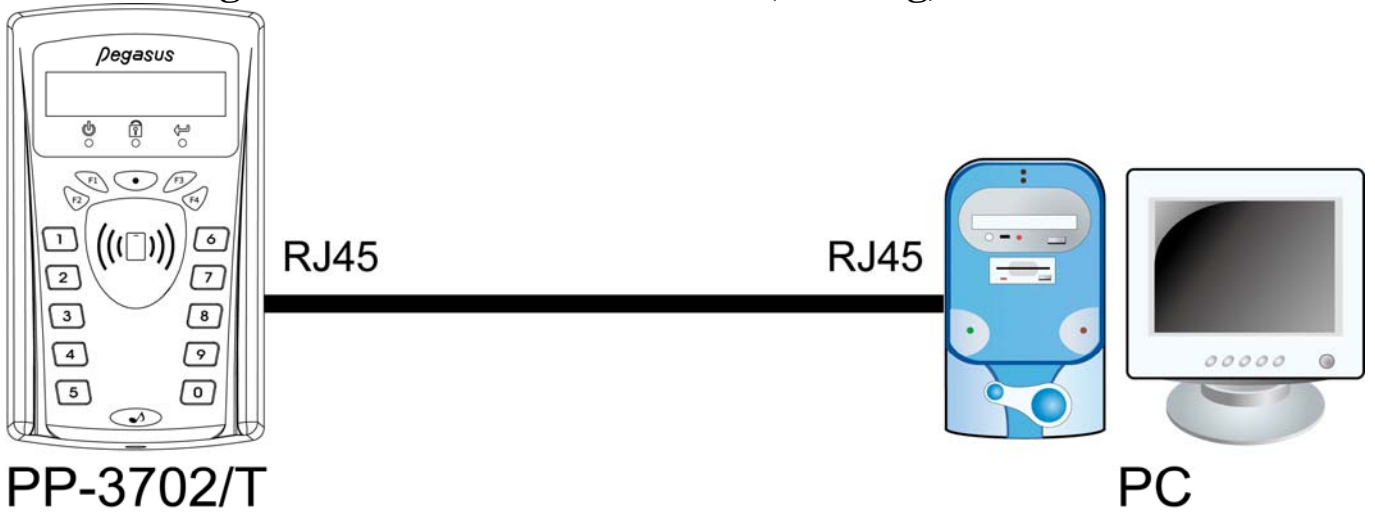

How to connect PP-3702T to a computer?

Change IP address(IE only) & change Ports setting

a. Change IP address(IE only)

1. Start IE (Internet Explorer), keyin IP address: 192.168.1.120 on internet to start the setting.
2. Select DHCP Mode to Static IP, and key-in IP address.



The screenshot shows the Controller Setup Basic Settings page in Internet Explorer. The URL bar shows <http://192.168.1.120/pass.cgi?password=&Submit=Login>. The page title is "Controller Setup" and the section is "Basic Settings". The form contains the following fields:

IP Address:	192	168	1	120
Subnet Mask:	255	255	255	0
Gateway IP:	192	168	1	1
DHCP Mode:	Static IP			
Device Numbers:	0			
Login Password:				

An "Update" button is located at the bottom right of the form.

3. Press “**Update**” for upload complete.
 - IP Address: Please search useful/ vacancy IP address.
 - Subnet Mask/ Gateway IP: Please compliance Internet of Ethernet or check “Start”→”run”→key in ”cmd” then click “OK”→keyin “ipconfig” to get the information.

b. Change serial ports

1. Please set Serial Port1.

Serial Port1		
	Current	Updated
Baud Rate:	9600 bits/second	115200 <input type="text"/> bits/S
Data Size:	8 bits/character	8 <input type="text"/> bits/character
Parity:	None	None <input type="text"/>
Stop Bits:	1 bit(s)	1 <input type="text"/> bit(s)
Interface:	None	RS232 <input type="text"/>
Local Telnet Port Number:	4001	4001 <input type="text"/>
Telnet Mode:	Raw	TCP Server <input type="text"/>
Telnet Protocol:	Raw	Raw <input type="text"/>
Telnet Server IP:	N/A	<input type="text"/> . <input type="text"/> . <input type="text"/> . <input type="text"/>
Remote Telnet Port Number:	N/A	<input type="text"/>
Client Connection:	Auto	Auto <input type="text"/>
Telnet Timeout:	0 minutes	<input type="text"/> minutes (0 for no timeout)
	<input type="button" value="Update"/>	

- 1) Baud Rate: 9,600
- 2) Data Size: 8
- 3) Interface: RS232
- 4) Local Telnet Port Number: 4001
(*Note: Our software uses socket port “4001”)
- 5) Click “” for complete setting.

2. Please set Serial Port2.

Serial Port2		
	Current	Updated
Baud Rate:	9600 bits/second	115200 <input type="text"/> bits/S
Data Size:	8 bits/character	8 <input type="text"/> bits/character
Parity:	None	None <input type="text"/>
Stop Bits:	1 bit(s)	1 <input type="text"/> bit(s)
Interface:	None	Auto <input type="text"/>
Local Telnet Port Number:	4001	4001 <input type="text"/>
Telnet Mode:	Raw	TCP Server <input type="text"/>
Telnet Protocol:	Raw	Raw <input type="text"/>
Telnet Server IP:	N/A	<input type="text"/> . <input type="text"/> . <input type="text"/> . <input type="text"/>
Remote Telnet Port Number:	N/A	<input type="text"/>
Client Connection:	Auto	Auto <input type="text"/>
Telnet Timeout:	0 minutes	<input type="text"/> minutes (0 for no timeout)
	<input type="button" value="Update"/>	

- 1) Baud Rate: 9,600
- 2) Data Size: 8
- 3) Local Telnet Port Number: 4001 (Note: Our software uses socket port “4001”)
- 4) Click “” for complete change.

Example of how to wiring

1. Wiring connection with external relay and power supply (such as electric strike lock)

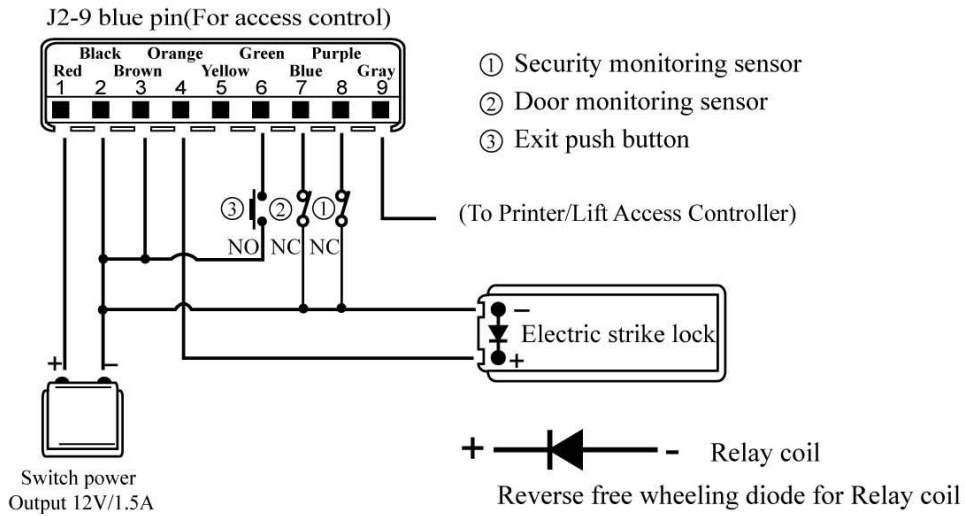

2. Wiring connection with external relay and power supply for heavy load locks (such as magnetic lock or drop bolt type lock)

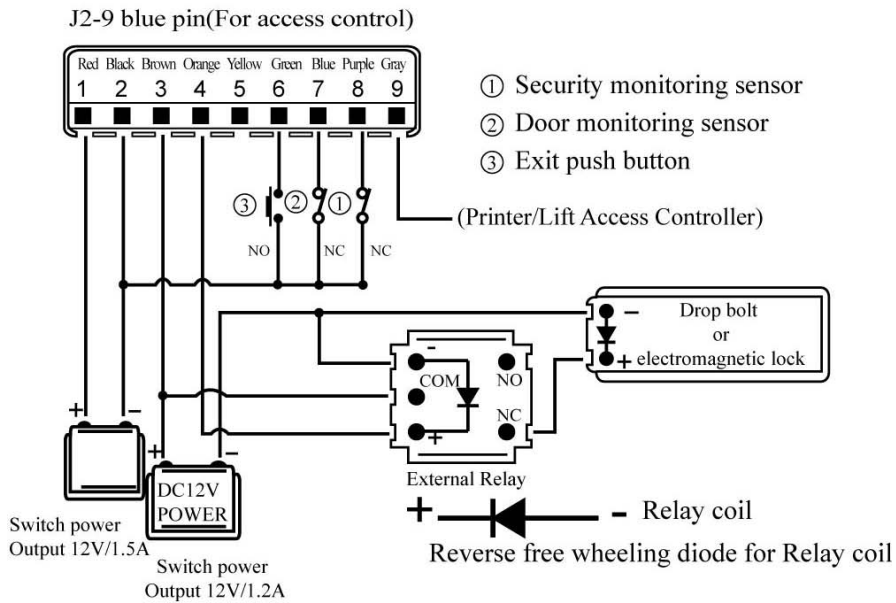

3. 8F relay box connector

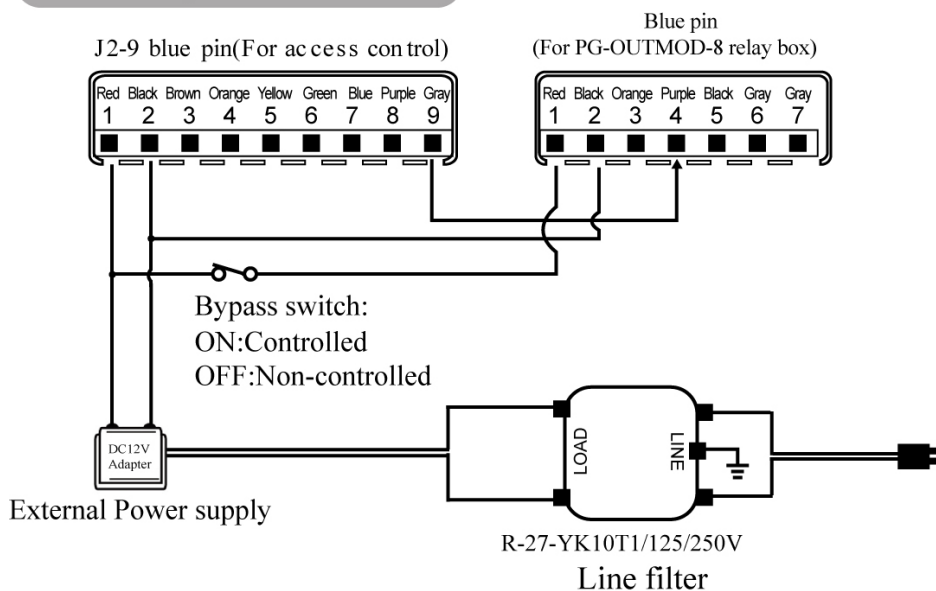

4. 24F relay box connector

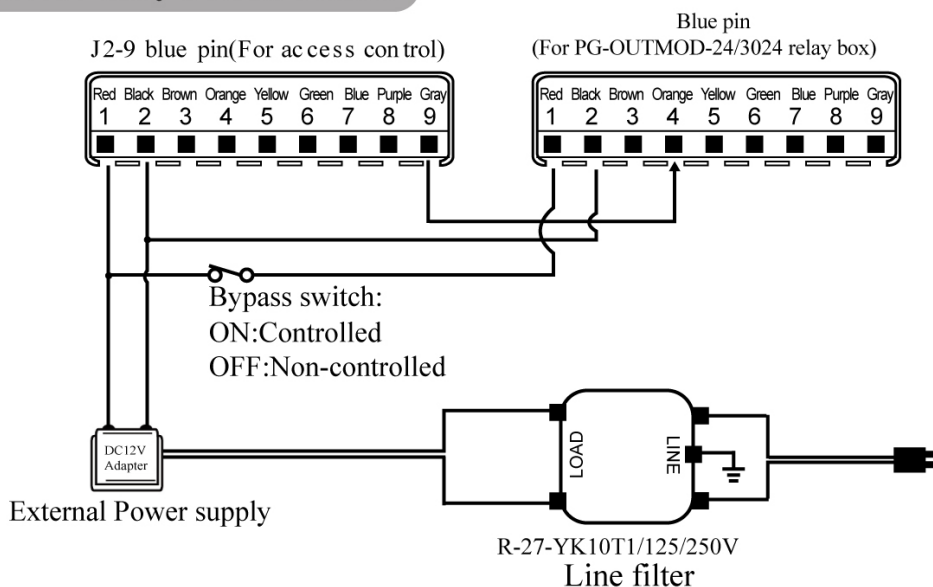

- ※R-27-YK10T1/125/250V is line filter to avoid signal interference.
- ※If elevator controller doesn't work; please turn off "Bypass switch" of non-controlled button.
- ※To connect 2 or 3 of 24 floor controllers to achieve 64 floors access of set up.
- ※Please refer appendix for floor controller of related operation manner.

Controller and relay box wiring example

PP-3702/T		PG-OUTMOD-8 Relay Box	
9 Pin Blue Connector		J5-7 Pin Blue Connector	
<u>Color</u>	<u>Signal Name</u>	<u>Color</u>	<u>Signal Name</u>
No1.Red	+12V	No1.Red	+12V
No2.Black	GND	No2.Black	GND
No3.Brown		No3.Orange	No Connection
No4.Orange		No4.Purple	Serial Printer Input
No5.Yellow		No5.Black	No Connection
No6.Green		No6.Gray	No Connection
No7.Blue		No7. Gray	No Connection
No8.Purple			
No9.Gray	Serial Printer Output		

PP-3702/T		PG-OUTMOD-24 Relay Box	
9 Pin Blue Connector		J5-9 Pin Blue Connector	
<u>Color</u>	<u>Signal Name</u>	<u>Color</u>	<u>Signal Name</u>
No1.Red	+12V	No1.Red	+12V
No2.Black	GND	No2.Black	GND
No3.Brown		No3.Brown	No Connection
No4.Orange		No4.Orange	Serial Printer Input
No5.Yellow		No5.Yellow	No Connection
No6.Green		No6.Gree	No Connection
No7.Blue		No7. Blue	No. Connection
No8.Purple		No.8 Purple	
No9.Gray	Serial Printer Output	No.9 Gray	

System initialize (default password 246890)

The system initialization means the system parameters are defaulted by F4=0850(off-line mode) or F4=0750(on-line mode). Then the user could modify some parameters based on it. After each modification to individual requirement, the user may backup them by code F4=0650. Once the parameters are destroyed, the code F4=0950 could be applied to restore it. All the function code under F4 is disabled, except the timer for 21tt, 22.....

- 1. Door monitoring:** : Disable the door monitor function (F4=1100)
- 2. Personal map compare** : Not compare (F4=1500)
- 3. Door release time** :close one second(F4=2101)
- 4. Door open mode** : card only mode(F4=3200)
- 5. Anti-pass back mode** : Disable (F4=3900)
- 6. Check repeat card** : Disable(F4=8300)
- 7. Printer output function** : Disable (F4=8600)
- 8. When event buffer full** : Not recycle (F4=8700)
- 9. Computer connect mode** : real time mode (F4=8903)-F4=0750
batch mode (F4=8900)-F4=0850

Operating instruction

The manager could program the controller by pressing “0” and master PIN (default password as “246890”.The password could be modified by F4=4609) to enter into the PROGRAM mode.

Summary of functions code please refer to index on the system introduction.

- F0 【0】** : Delete all personal map
- F1 【1】** : Key in user ID for access by master PIN
- F2 【2】** : Set weekday, hour, minute
- F3 【3】** : Program Calendar year, month and date
- F4 【4】** : Parameter modes & Modes
- F5 【5】** : Inquiry Personal access map
- F6 【6】** : Add personal map
- F7 【7】** : Delete personal map
- F8 【8】** : Time zone/holiday/bell programming & Inquiry
- F9 【9】** : Modify events counter for event retrieving
- F10 【*】** : Display or print out recorded

Note : The programming procedures could be escaped by pressing “#” by key.

Brief system programming

Change the master PIN

Ex. Change the master PIN to 654321 , than F4+4609+654321. The new master PIN would be changed to 654321

Step	LCD	Description
Press[0] + master PIN [246890]	* PROGRAM * -->	Enter into programming mode
Press[4]	* FUNC-->-----	Parameter mode (F4)
Press[4609] +new master PIN[KKKKKK]	MST.PIN- KKKKKK >	KKKKKK would be the Password

Function code instruction

F0: Delete all personal map

Step	LCD	Description
Press[0] + master PIN [246890]	* PROGRAM * -->	Enter into programming mode
Press[0]	* CLRALL > -----	Delete mode(F0)
Press [0000]	END---	
Repeat the last step or press [#] to escape from the programming.		

F1: Direct keying master PIN

Ex. : Administrator puts in 8 codes ID of user with the personal password for a user when someone forgets bring his card

※The personal password is set up by F4=3300(read a card with password model) + F6(setting personal password). Above setting can be done on the controller or computer.

Step	LCD	Description
Press[0] + master PIN [246890]	* PROGRAM * -->	Enter into programming mode
Press[1]	* ID No. > -----	Access mode(F1)
Press card number [12345678]	* PIN--- >	Put in the legal card numbers
Press personal password [9999]		Put in the personal password

F2: Weekday, hour, minute setting

Step	LCD	Description
Press[0] + master PIN [246890]	* PROGRAM * -->	Enter into programming mode
Press[2]	* TIME-->-----	Time mode (F2)
Press[201536]		Tuesday, 15:36 pm

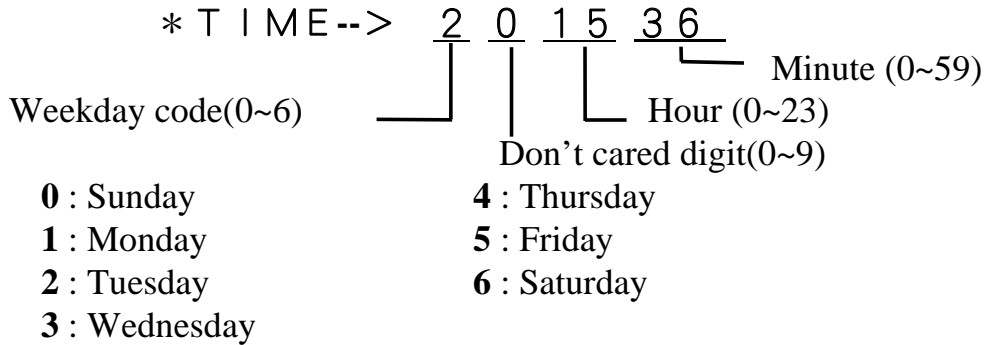

F3: Calendar year, month and date setting

Step	LCD	Description
Press[0] + master PIN [246890]	* PROGRAM * -->	Enter into programming mode
Press[3]	* YEAR-->-----	Date mode (F3)
Press[091025]		2009/10/25

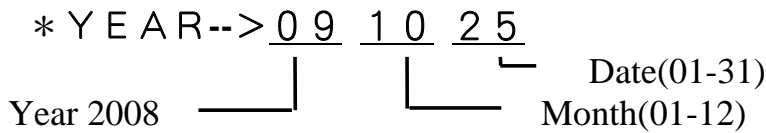

After key 0 + (default master PIN) then you could press 4 plus following function codes divided in groups for easy memorize.

F4: Most system parameters programming

Step	LCD	Description
Press[0] + master PIN [246890]	* PROGRAM * -->	Enter into programming mode
Press[4]	* FUNC-->-----	Parameter mode (F4)
Press 4 digit function code	* FUNC-->XXXX	
Please refer to the function code		

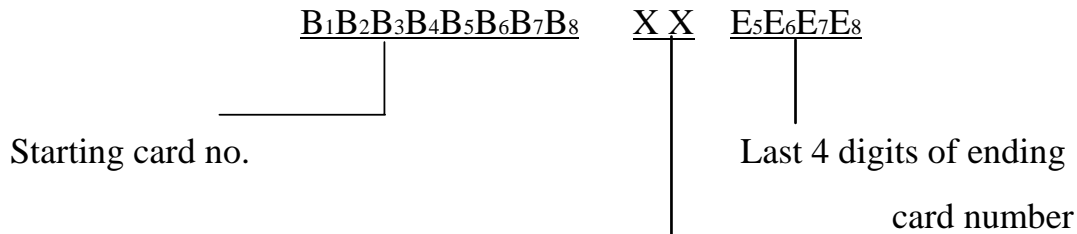

- Time zone status (F4=1601)
- 00: Illegal
 - 10: **Clear** all time zones
 - 19: **Authorize** all time zones
 - 1n: **Authorize** individual time zone (1~8)

F6: Add personal map

A. Add card no. with group number : (Under F4=3200)

Step	LCD	Description
Press[0] + master PIN [246890]	* PROGRAM * -->	Enter into programming mode
Press[6]	* ADD CR → -----	Add mode(F6)
Press card NO.[12345678nn]	* ADD CR >	Add card no.12345678, And group no. nn (nn=00-99)

Repeat the last step or press [#] to escape from the programming.

B. Add card No. and PIN (Under F4=3300)

Ex. : Set up card No.=12345678 and PIN=9999, group No. 02

Step	LCD	Description
Press[0] + master PIN [246890]	* PROGRAM * -->	Enter into programming mode
Press[6]	* ADD CR → -----	Add mode(F6)
Press [12345678 02 9999]	* ADD CR → -----	Card number:12345678 Group: 2 Password: 9999

Repeat the last step or press [#] to escape from the programming.

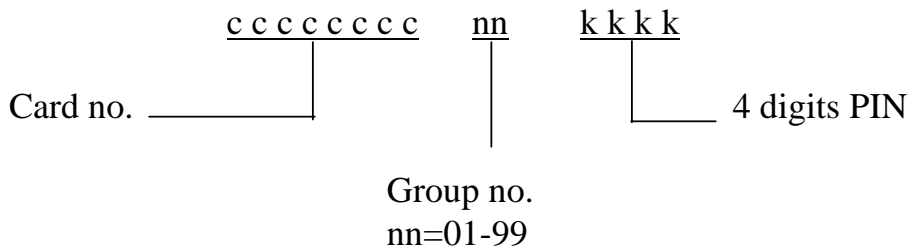

C. Add card with learning mode: (F4 = 6333)

Step	LCD	Description
Press[0] + master PIN [246890]	* PROGRAM * -->	Enter into programming mode
Press[4]	*FUNC →	Add mode(F4)
Press[6333]	*ADD CR>-LEARN->	Learning mode
Present card	*ADD CR>-LEARN-> C ₁ C ₂ C ₃ C ₄ C ₅ C ₆ C ₇ C ₈	
Repeat the last step or press [#] to escape from the programming.		

D. Add card by block mode: (F4 = 6600)

Ex.Add card no. from 00020376 to 00020576, group no.01

Step	LCD	Description
Press[0] + master PIN [246890]	* PROGRAM * -->	Enter into programming mode
Press[4]	*FUNC →	Add mode(F4)
Press[6600]	* ADD CR > -BLOCK->	block mode
Press [00020376 01 0576]		from 00020376 to 00020576, group no.01
Repeat the last step or press [#] to escape from the programming.		

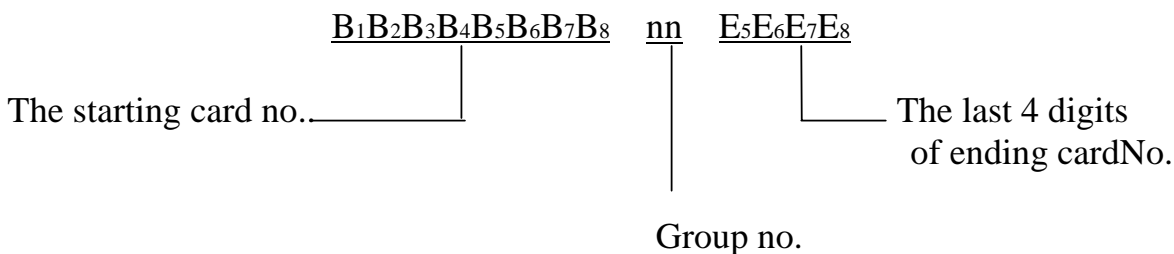

F7: Delete personal map

A. Delete single card

Step	LCD	Description
Press[0] + master PIN [246890]	* PROGRAM * -->	Enter into programming mode
Press[7]	* DELETE > -----	Delete mode(F7)
Press card No.[12345678]	* DELETE > -----	Delete card No.12345678
Repeat the last step or press [#] to escape from the programming.		

B. Delete card with leaning mode (F4=7333)

Step	LCD	Description
Press[0] + master PIN [246890]	* PROGRAM * -->	Enter into programming mode
Press[4]	* FUNC →	Parameter mode(F4)
Press[7333]	* DELETE >-LEARN->	learning mode
Present card	* DELETE >-LEARN-> CCCCCCCC	Reading cards to delete cards
Repeat the last step or press [#] to escape from the programming.		

C. Delete time zone from group nn(nn=01~99)(F4=72nn)

Step	LCD	Description
Press [0] + master PIN [246890]	*PROGM*-->	Enter into programming mode
Press [4]	* FUNC -- > --	Parameter mode(F4)
Press [72nn]	* DELETE>-GROUP->	Group [nn]
Press [81828384]	* DELETE>-----	Delete time zone 1,2,3,4, 5,6,7,8
Press [85868788]	* DELETE>-----	
Press [#]to escape from the programming.		

D. Delete card with block mode: (F4 = 7700)

Ex. Delete card no. from 00020376 to 00020576

Step	LCD	Description
Press[0] + master PIN [246890]	* PROGRAM * -->	Enter into programming mode
Press[4]	* FUNC →	Parameter mode(F4)
Press [7700]	* DELETE > -BLOCK->	Delete with block mode
Press [00020376 nn 0576]		from 00020376 to 00020576
Repeat the last step or press [#] to escape from the programming.		

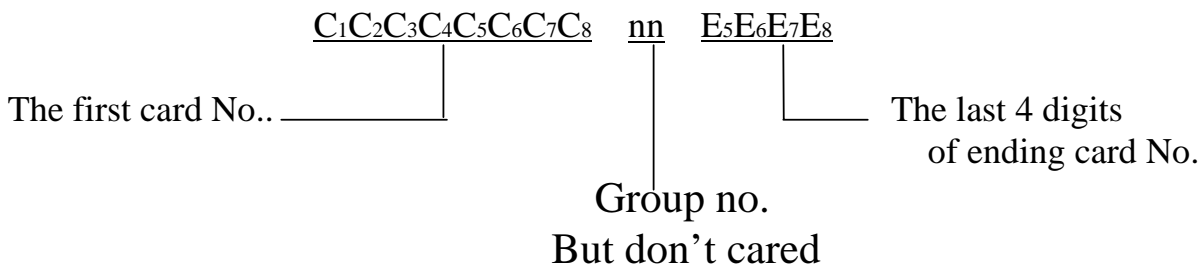

F8: Time zone/holiday/bell programming

- A. Personalized mode (F4=1601, time zone 01~08)
- B. Free access mode (F4=3801, time zone 11~18)
- C. Holiday mode (F4=1801)
- D. Bell alarm mode (F4=2801)

A. Access time zone setting

Ex. define a time zone from 20:01 till 06:59 next day for Monday, Tuesday & Friday. Please define by TZ1= 2001-2359 and TZ2= 0000-0659 for crossing midnight

Step	LCD	Description
Press[0] + master PIN [246890]	* PROGRAM *-->	Enter into programming mode
Press [8]	* ZONE-->-----	Time zone mode(F8)
Press [601 2001 2359]	* G · DAY->	The first time zone is 20:01pm to 23:59pm
Press [1 1111111 1]	* ZONE-->-----	Available for Monday to Sunday
Press [602 0000 0659]	* G · DAY->	The second time zone is morning of next day 00:00am to 06:59am
Press [0 0100110 1]	* ZONE-->-----	Available for Monday to Sunday
Repeat the last step or press [#] to escape from the programming.		Setting 8 time zones the most

* Z O N E --> 6 0 n HHMM hhmm

6: Add time zone ————
 Time zone (01—08) ————

Starting time

Ending time
 hh: hour (00~23)
 mm: minute (00~59)

G-DAY: defined as the following:

<u>d1</u>	<u>d2</u>	<u>d3</u>	<u>d4</u>	<u>d5</u>	<u>d6</u>	<u>d7</u>	<u>d8</u>	<u>d9</u>
Mnemonic g	w6	w5	w4	w3	w2	w1	w0	D
meaning gen.	Sat	Fri	Thu	Wed	Tue	Mon	Sun	Duty code

d1— **general week** enable/disable

=1: general authorized, d2 ~ d8 are ignored

=0 : not general authorized, d2 ~ d8 should be entered **one by one**

d2 ~ d8—**individual weekday** enable/disable

= 1: legal

= 0: denied

d9—Auto mode by time zone

= 1: with key

= 0: keypad less

A-1 Time Zone Mode/Add Card Mode

62nn Setting time zone for group (nn=01~99) (Under F=1601)

Note: Please delete all group data for first time setting group. (F4=0072)

Step	LCD	Description
Press [0] + master PIN [246890]	*PROGM*-->	Enter into programming mode
Press [4]	* FUNC -- > --	Parameter mode(F4)
Press [62nn]	* ADD CR>-GROUP->	Group [nn]
Press [81839999]	* ADD CR>-----	Legal time zone 1,3
Press [#] to finish.Please repeat the step 4 for adding the fifth time zone.You should fill out 8 digits for time zone and fill with 99.. for blank time zone like85869999 which is legal for time zone 5 and 6.		

A-2. Group with floor setting (put in floor number 01~96) (F4=8613/8623/8633)

Step	LCD	Description
Press [0] + master PIN [246890]	*PROGM*-->	Enter into programming mode
Press [4]	* FUNC -- > --	Parameter mode(F4)
Press [62nn]	* ADD CR>-GROUP->	Group [nn]
Press [01020363]	* ADD CR>-----	Legal 1th,2th,3th and 63th floors
Press [#] to finish.Please repeat the step4 for adding the fifth floor.You should fill out 8 digits for floor and fill with 99.. for blank floor like 05069999 which is legal for 5th and 6th floors.		

A-3. Personalized time zone inquiry (time zone=01~08)

Step	LCD	Description
Press[0] + master PIN [246890]	* PROGRAM * -->	Enter into programming mode
Press [8]	* ZONE-- > -----	Time zone mode(F8)
Press [5 0 2 0 0 0 0 0 0 0]	ZONE-- > ----- 02=0900=1000=GA1	

* Z O N E --> 5 0 n xxxxxxxx
 5: Inquiry time zone content |
 Time zone no. (01-08) | Any 8 digits key

A-4. Delete time zone

Step	LCD	Description
Press[0] + master PIN [246890]	* PROGRAM * -->	Enter into programming mode
Press [8]	* ZONE-- > -----	Time zone mode(F8)
Press[702 0 0 0 0 0 0 0 0]		Delete time zone 2

7: Time zone deletion |
 Time zone (01-08) | Any key (8 digits)

B. Free access mode (Time zone=11~18) (F4=3801)

Ex. Door released period decided by Nth time zone 0900-1800 on Saturday & Sunday

Step	LCD	Description
Press[0] + master PIN [246890]	* PROGRAM * -->	Enter into programming mode
Press [8]	* ZONE-- > -----	Time zone mode(F8)
Press [611 0900 1800]	* G · DAY-- > -----	Door released under normal open mode on Monday to Sunday
Press [0 100000001 1]	* ZONE-- > -----	
Repeat the last step or press [#] to escape from the programming.		Setting 8 time zones the most

Zone: defined as the following:

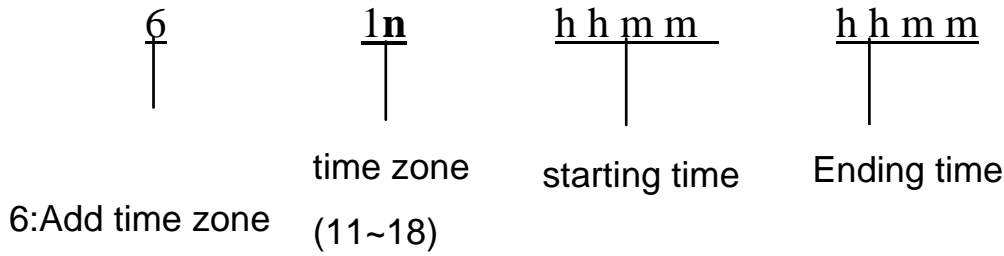

B-1. Auto duty mode (Time zone=11~18)(F4=3802)

Step	LCD	Description
Press[0] + master PIN [246890]	* PROGRAM *-->	Enter into programming mode
Press [8]	* ZONE-- >-----	Time zone mode(F8)
Press [611 0900 1200]	* G · DAY-- >-----	Time zone 09:00-12:00
Press [1 1111111 1]	* ZONE-- >-----	Shift code is 1 for Monday to Sunday
Repeat the last step or press [#] to escape from the programming.		Setting 8 time zones the most

Zone: defined as the following:

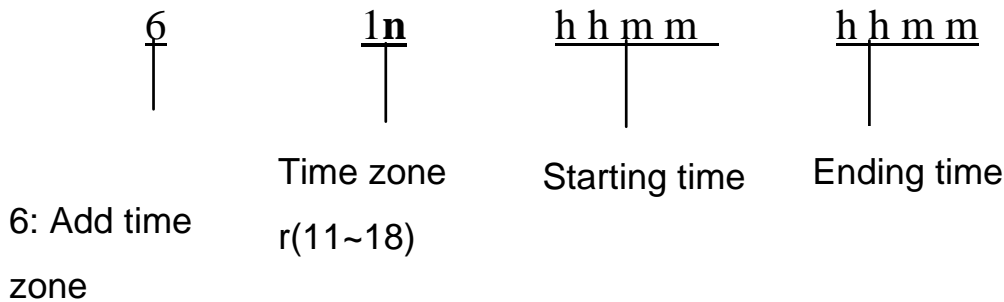

G-DAY: defined as the following:

<u>d1</u>	<u>d2</u>	<u>d3</u>	<u>d4</u>	<u>d5</u>	<u>d6</u>	<u>d7</u>	<u>d8</u>	<u>d9</u>
Mnemonic g	w6	w5	w4	w3	w2	w1	w0	D
meaning gen.	Sat	Fri	Thu	Wed	Tue	Mon	Sun	Duty code

d1— **general week** enable/disable

=1: general authorized, d2 ~ d8 are ignored

=0 : not general authorized, d2 ~ d8 should be entered **one by one**

d2 ~ d8—**individual weekday** enable/disable

= 1: legal

= 0: denied

d9—Auto duty mode by time zone

= 1: enable(1~7), expect 4

= 0: disable

Duty code	LCD display	Meaning	Duty code	LCD Display	Meaning
1—	WORK	On duty	5--	OUT	Out
2—	OFF	Off duty	6—	BACK	Return job
3—	O.ON	Over time, on duty	7--	BRK	Break
4—	SYSTEM	Reserved for system service only	8—	DUTY.	2 digits job code define by user

B-2. Auto mode (Time zone no.=11~18)(under F4=3803)

Step	LCD	Description
Press[0] + master PIN [246890]	* PROGRAM * -->	Enter into programming mode
Press [8]	* ZONE-->-----	Time zone mode(F8)
Press [611 1900 2359]	* G · DAY-->-----	Time zone 09:00~23:59
Press [1 1111111 1]	* ZONE-->-----	Password is required after presenting a card for Monday to Sunday
Repeat the last step or press [#] to escape from the programming.		Setting 8 time zones the most

Zone: Defined as the following

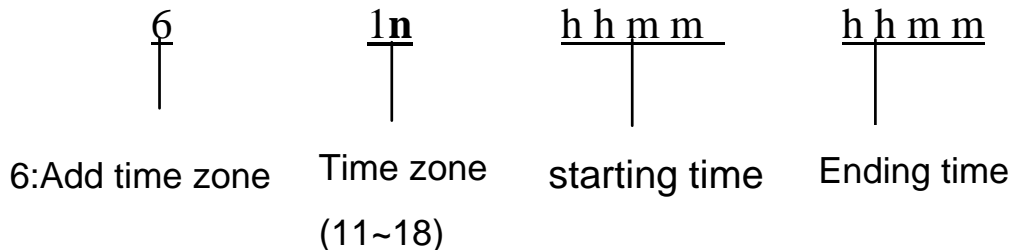

G-DAY: Defined as the following:

	<u>d1</u>	<u>d2</u>	<u>d3</u>	<u>d4</u>	<u>d5</u>	<u>d6</u>	<u>d7</u>	<u>d8</u>	<u>d9</u>
Mnemonic	g	w6	w5	w4	w3	w2	w1	w0	D
Meaning	gen.	Sat	Fri	Thu	Wed	Tue	Mon	Sun	Duty code

d1— **general weekdays** enable/disable

=1: general authorized, d2 ~ d8 are ignored

=0 : not general authorized, d2 ~ d8 should be entered **one by one**

d2 ~ d8— **individual weekday** enable/disable

= 1: legal

= 0: denied

d9—Auto mode by time zone

= 1: with key

= 0: keypad less

C. Programming Holidays (F4=1801)

Step	LCD	Description
Press[0] + master PIN [246890]	* PROGRAM * -->	Enter into programming mode
Press [8]	* ZONE-->-----	Time zone mode(F8)
Press [101 1001 1010]	* ZONE-->-----	1001: the first holiday of October, date of 10/10
Press [102 1002 1025]	* ZONE-->-----	1002: the second holiday of October, date of 10/25
Press [103 1003 1031]	* ZONE-->-----	1003: the third holiday of October, date of 10/31
Repeat the last step or press [#] to escape from the programming.		Setting 8 holidays the most

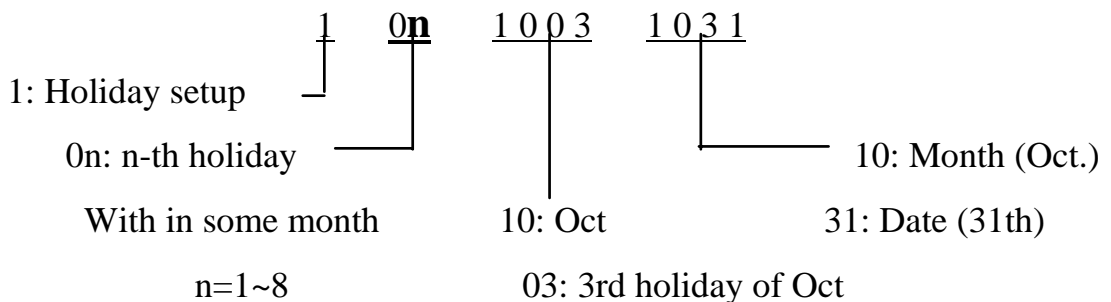

D-1. Bell alarm inquiry mode (F4=2801)

Step	LCD	Description
Press[0] + master PIN [246890]	* PROGRAM * -->	Enter into programming mode
Press [8]	* ZONE-- > -----	Time zone mode(F8)
Press [40107010000]	401=0750=0750=ALM	Please refer to the following statement
Repeat the last step or press [#] to escape from the programming.		

Meaning: 7:50 is the 1st alarm time at 7 o'clock

4: Bell alarm inquiry 4 0n 070n 0000
 0n: n-th timer The nth bell alarm Any key
 n=1~6 in 7 o'clock

Note: Under F4=2801, the bell alarm period is decided by 220t; meanwhile 2801 & 1101 code should mutually trade-off. (If 2801 is set, the 1101 should be denied as 1100)

F9: Modify events counter for event retrieving

Ex. Modify the Read/write counters to 00150

Step	LCD	Description
Press[0]+masterPIN[246890]	* PROGRAM * -->	Enter into programming mode
Press[9]	* CNT St > -----	Read/write counter mode(F9)
Press [100 150]	DON-000150	Read/write counter is 6 digits

Modify read or write counter only:

Modify **write** counter only: F9=>200150

Modify **read** counter only: F9=>100150

When "2" means write counter

When "1" means read counter

F * : Inquiry and display the stored events

Ex.: Modify the read/write counter to 00150

Step	LCD
Press[0] + master PIN [246890]	* PROGRAM * -->
Press[*]	* DSPLAY=-----
Press [50000150]	*DSPLAY= <u> d d </u> <u> HH : MM </u> CCCCCCCC S [NNNNNN]

- dd : Date
- HH : MM Hour & Minute
- ccccccc : 8 digits ID number
- S :Access status
- E: Error message
- D: Correct stored data
- NNNNN : Event counter

50 n n n n— n n n n is the top counter

To display all the record lower than the counter nnnn.

52 m m d d— m m = Month. d d = date.

To display the record for specific date from existing counter downward.

53 w 0 0 0— w = Weekday. 0 0 0 = meaningless digits.

To display the record for specific weekday from existing counter downward.

After pressing 0 + (default master PIN),you could press 4 and the following function codes divided in groups for easy memory.

Group 0. SYSTEM INITIALIZATION

0000	Delete all personal access map (deny all legal persons access status) -take around seconds depending on the card capacity.
0016	Delete all time Zone data
0018	Delete all holiday data

0019	Delete all bell alarm data
0072	Delete all group data
0650	Save all the modified function codes as template(could be recalled by 0950)
0750	Initialize the system in real time on-line state. (The system will be initialized as: 2101, 2203, 2306, 2501, 1500, 1600, 1100, 3200, 8600, 8700, 1700, 8902, 1900.....) The user can use this code to initialize the system then adjust the other code to meet the requirement.
0800	Initialize the system all parameters(include Group9)
0850	Initialize the system in off-line state (same as 0750 except 8900)
0950	To recall the saved template.(Saved by 0650)

Group 1. INPUT

1100/1101	Disable/Enable the door monitoring function with enforce entry and door open too long .
1200/1201	Disable/Enable the security function with enforce
1500/1501	Not compare/ Compare individual personal map.
1600/1601	Not compare/ Compare personal time zone map.
1700	Immediately check APB (anti-pass back)
1701	Auto reset of anti-pass back function every 24 hours
1702	Auto reset of anti-pass back function every 36 hours
1703	Auto reset of anti-pass back function every 48 hours
1701~1703	Are pair with 1700~1703 for different mode
1800/1801	Not compare/ compare holiday.
1900/1901	Not compare/ compare project number. (for p p p . c c c c c format only)

Group 2. OUTPUT

21tt	tt: Door release time from 01 to 98 in unit of 1 seconds. 2199: Output becomes normality, both on or off to switch.
22tt	Alarm time . tt= 00 to 99 in unit of 1 seconds.
23tt	Door monitoring time.tt=00 to 99 in unit of 1 seconds.
240n	Trial error alarm, n= error times.
25tt	tt:display time from 01 to 97 in unit of 1 seconds.
2600/2601	Disable/ enable expiry date check (validity date programmed by PC only).
*2700	Display fix duty name by ROM.
*2701	Definable duty name by PC.
*2702/04/08	2/ 4/ 8 digit duty name.
2801	Enable bell alarm mode (Trade-off with 1101).
*2901	Enable staff Nr. Display.(Trade-off with 2601,1701-1703)

Group 3. OPERATION MODES

3200	Card only mode
3300	Card + PIN mode
3301	External reader needs to press PIN too(for 3300 mode)
3400	Disable 3401/3402
3401	Enable card No.+ PIN code key only mode by keying. (Press * + card No.+ PIN code)
3402	Enable door PIN mode.(Press 7 + PIN code)
3500/3501	Unlock/Lock the keypad
3600	Disable 3601/3602
3601	Enable duress code for card No.+PIN
3602	Enable duress code for door PIN

Note: +1 or -1 of independent pass code, the door will be unlocked and trigger to Alarm system.

Ex.If the door pin is set up as 1234, the duress code will be 1233 or 1235.

* 3700	Delete the project number by direct reading card
* 370n	Record the project number by direct reading card for comparing project number (9806/9816 format only)
3800	Disable all following 3801, 3802, 3803 modes
3801	Enable free access modes
3802	Enable auto duty (shift) code mode
3803	Enable automatic operation mode
Only one mode among 3801, 3802, 3803 is allowed	
3900/ 3901	Disable/ Enable Anti-passback mode

Group 4. DOOR OR MASTER PIN SETTING

4601~4607	Set the 4 digits door PIN (Under F4=3402)
4609	Set the 6 digits master PIN for system login.

Group 5. CARD INQUIRY

5333	Inquiry card status by reading card (learning mode)
5500	Inquiry card status for block range

Group 6. TIME ZONES OR FLOORS SETTING MODE/ADDING CARD BY LEARNING OR BLOCK RANGE

62nn	Setting time zone for group (nn=01~99,)(Under F=1601)
Note:Please delete all group data for first time setting group. (F4=0072)	
6333	Add single card reading learning mode
6600	Add card with block mode

Group 7. CARD DELETING

- 72nn** Delete time zone from group nn(nn=01~99)
- 7333** Delete single card with auto learning mode
- 7700** Delete card with block mode

Group 8. SYSTEM CONFIGURATIONS

8300/830t	Not check repeat reading/ Present repeat reading within t minutes.			
840X	8400 Non-store the error even 8401 Store the error event 8402 Store the event of exit push button 8403 Store the event of error and exit push button			
8599	Send out all personal map (for PC on-line test only) by test com			
8600	Disable direct printer output.			
8601	Enable direct printer output. (With RS-232C interface)			
8603	Enable direct printer output. (with RS-485/232C interface)			
86	F(floor)		S(serial output)	
	F=0	Without lift output (for access only)	S=0	Enable output
	F=1	8 floor	S=1	RS-232 output
	F=2	24 floor	S=2	RS-485 output
	F=3	48 floor ~64 floor	S=3	RS-232/RS-485 output
Ex. 8611 For setting 8 floor relay output via RS-232				
*8691 96 floor output(without time zone function)(optional)				
8700	For F1F0 mode			
8701	The reading counter may over writing counter (not suggested)			
88aa	Set device address as aa for polling.			
890n	If n=0, the system is off-line (batch mode) If n=3, the system is on-line (real-time mode), if not necessary, we suggest 8900 to shorten the access response time			

Group 9. FACTORY CONFIGURATION

92nn	nn=00~31 the modification factor as the RTC is fast nn=32~63 the modification factor as the RTC is slow Example: as the crystal is faster than 2Hz, then the factor is 21(F4=9221)																																																																
* 9600/9601	Disable/ enable name display.																																																																
* 970N	Select the card digits as group index for comparing. <table border="1" style="margin-left: 20px;"> <tr> <th colspan="8">Card number</th> </tr> <tr> <td>1</td><td>2</td><td>3</td><td>4</td><td>5</td><td>6</td><td>7</td><td>8</td> </tr> <tr> <td colspan="3">9700</td><td colspan="5"></td> </tr> <tr> <td colspan="2">9701</td><td colspan="4"></td><td colspan="2"></td> </tr> <tr> <td colspan="1">9702</td><td colspan="3"></td><td colspan="2"></td><td colspan="2"></td> </tr> <tr> <td colspan="1">9703</td><td colspan="2"></td><td colspan="2"></td><td colspan="2"></td><td></td> </tr> <tr> <td colspan="1">9704</td><td colspan="1"></td><td colspan="3"></td><td colspan="2"></td><td></td> </tr> <tr> <td colspan="1">9705</td><td colspan="1"></td><td colspan="1"></td><td colspan="4"></td><td></td> </tr> </table>	Card number								1	2	3	4	5	6	7	8	9700								9701								9702								9703								9704								9705							
Card number																																																																	
1	2	3	4	5	6	7	8																																																										
9700																																																																	
9701																																																																	
9702																																																																	
9703																																																																	
9704																																																																	
9705																																																																	
* 9781	Reverse the Wiegand number for decoding (New version firmware)																																																																
98pd	To define the card display format																																																																
P=Format	d=Card format																																																																
P=0 PN format as wiegand 34 bit	d=3 p p p . c c c c c																																																																
P=1 PP format as wiegand 34 bit	d=5 35bits HID																																																																
P=2 PN format as wiegand 26 bit	d=6 0 0 0 c c c c c																																																																
P=3 PP format as wiegand 26 bit	d=8 C ₁ C ₂ C ₃ C ₄ C ₅ C ₆ C ₇ C ₈																																																																
Baud rate (factory default 9996=9,600BPS) :																																																																	
9996	9,600 bps																																																																
9948	4,800 bps																																																																
9924	2,400 bps																																																																
Ordered before shipping (due to need to change crystal) :																																																																	
* 9919	19,200 bps																																																																
* 9938	38,400 bps																																																																

* : Optional

Simple and easily trouble shooting

Questions concerning the card reader

#Symptom 01: The reader can not read card and get access

- A.1—To check whether the proximity card is encoded correctly. Either correct project number or card type. .
- A.2—To check whether the proximity card is legal.
- A.3—To check if the personal ID is enrolled in the reader by function F6 of card adding.

#Symptom 02: The reader can read card but can not get access

- A.1—To check if the reader is at 3300 mode (card with code),the reader lit green LED at left and you do not key-in the PIN within the keypad waiting time.
- A.2—To check if the reader is at 830t mode (unauthorized repeat card within t minutes), if yes, you should try to get access after t minutes. If 830t isn't the mode you want, then you may change it to 8300 code.

#Symptom 03: The reader can get access (LED displayed “good” or LCD displayed “---O.K.---“, but the door was not released.

- A.1—To check if you correctly wire the electrical lock device with the correct power supply.
- A.2—If the devices are all correctly wired and the wire is well conducted, then hear if the relay is clicked. If yes, then the relay contacts may be damaged. If not click, then the relay driver in the circuit board may be bad or damaged. Please contact with the distributor for repair or replacement.

© Wrong message on LCD display:

- C.ERR –Illegal card no.
- A.ERR –Anti-pass back error
- Z. ERR –Time zone error
- P. ERR – Password error
- Q. ERR –Project no. error
- V. ERR –Out of validity date
- RPT.ER *–Unable to read card repeatedly during the set time by parameter code 830t

#Symptom 04: The door was released but the duration is very short

- A.1—If the door released period is not so long as you set by 21tt,then please check if the door monitoring mode (1100/1)is set as 1101

mode and the door monitoring sensor doesn't normal closed as the door is held. In such condition, the door release driver will shut off the relay driver once it found the door is opened because the door sensor is left opened. Therefore, please replace the sensor or set the door monitoring mode as 1100 (not monitoring) before you replace the sensor.

A.2—If the door released period is not so long as you set by 21tt, but you have already disabled the door monitoring function by 1100 or although you actuate the door monitoring by code 1101, but the door sensor works normally, then this phenomena is resulted from the EMI interference from the drivered electrical device usually. If the coil of the door actuator or the external relay doesn't well protected by a reversed polarity free wheeling diode to suppress the interference for DC voltage driver or a surge absorber for AC voltage driver, the voltage transient pulse will let the CPU hold down or run into disorder or automatic reset and therefore shorten the door released time to around one second.

#Symptom 05: The counter can't be set by F9 counter setting

A.1—At first, if the address 880n is properly set. If the system address isn't properly set (Can be checked by "0" key) or is disturbed, then the reader won't store the event counter.

Questions concerning the card reader and its on-lined controller

(Any brand of PC or other dedicate controller)

#Symptom 01: The Personal Computer can not collect the data string from the reader(s) by standard software package.

A.1—At first, for on-lined application, the installer should utilize the terminal simulation software package such as TELEX,BITCOM etc. to test whether the wiring between the PC (and the Multi-channel controller PCP-832-xx or the RS-422/RS-232C converter or other 3rd partners interfacing devices for networking) and the readers are well connected and the communication parameters are selected correctly. At the same time, each reader should be set the correct parameters, unique reader address for each reader at the same wire cable for address mode by 88nn, 890n or 8900 for batch type or 890t for real time type..., etc. The reader address can definitely not be set the same for any two readers. The installer should be able to judge whether the wiring is

correct and solid reliable by viewing the terminal response from each reader.

A.2—If the supported PC standard software package for polling mode and through the multi-channel controller PCP-832-xx can set the system time and date, but cannot collect the stored or immediate data, then please check if the Data Terminal Ready (PIN G) is correctly connected with PIN 4 (Non-inverted Data Terminal Ready). At polling mode, if the real time data is ready or the buffer is not empty, then the PIN G should be at low voltage level less than 2.5 VDC. If at above condition but the voltage level is higher than 2.5 VDC at any side, please check if the wiring is correct.

#Symptom 02: The Personal Computer can not collect the data string through the linking driver in Clipper

A.1—Please check if the parameters of on-line (Such as 88aa and 890t of F4) are well programmed.

A.2—Please check if the reader is connected at COMM1.

A.3—Please check if EMM386.EXE in file of CONFIG.SYS is remarked and whether FILE/BUFFERS is opened as stipulated as
rem device=C:\windows\EMM386 I=e000-efff noems

A.4—Check whether the delay time in software is matched with executing time in the reader. Please adjust the delay time.
(It's better to turn off the TURBO function).

A.5—Please check whether TSR subroutine such as for MOUSE driving, FAX modem or Virus detecting program is standing in the memory. Please get rid of them if they exist in the memory.

Appendix

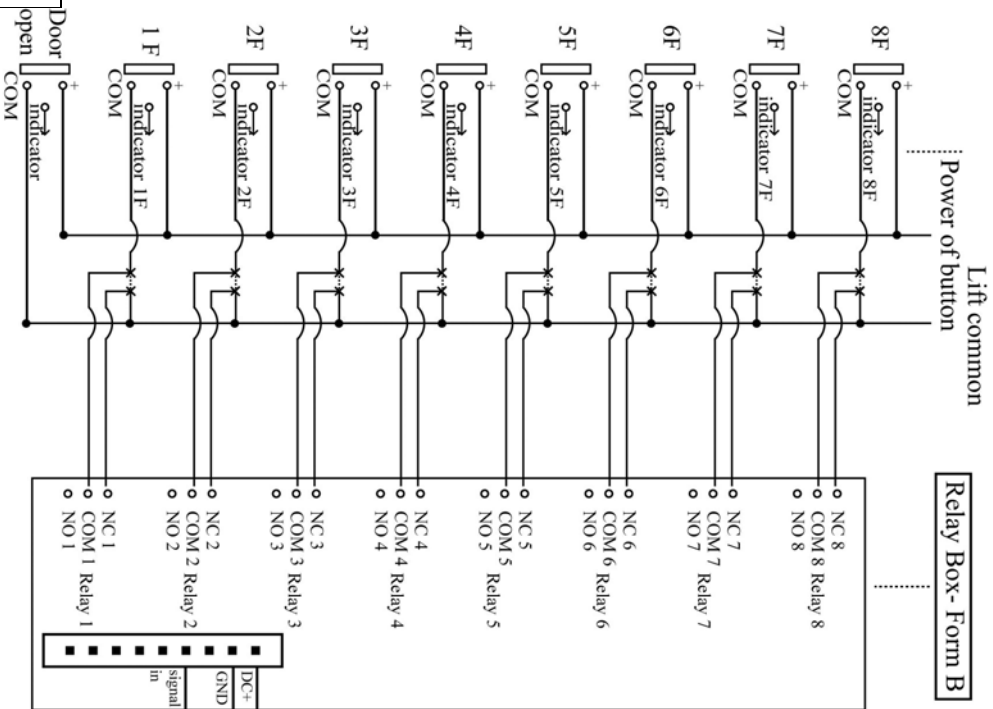

Diagram of lift controller & elevator wiring connection.

1. Subject to different elevator models of control circuit, the wiring connection will be changed accordingly. The best way we strongly recommend that every button control point is provided by elevator supplier.

2. There are two types of relay box for choice; form A or form B, and this diagram is showing with form B of relay box.

3. When the form B relay box is powered on, the status of relays will connect the Com. to NO. and then the relay box is powered off, the status of relays will be recovery.

Form A: We use the dry contact Com. & NO. to each floor button of elevator. Then we read a legal card, the related relays will start the current.

Form B: We use the dry contact Com. & NC. to each floor button of elevator. After power on, the relays will transform to stop the current. Then we read a legal card, the related relays will start the current.

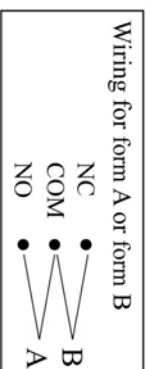

bypass switch :
Controlled---ON
Non-controlled---OFF

